

DM DESERT MACHINERY
آليات الصحراء

Perkins Denyo AIRMAN LINZ LEROY SOMER DSE ComAp
ABB LS Schneider Electric

CUMMINS GENERATOR

400 KVA (320 KW)

(INDIA)



Frequency: 60
Fuel Type: Diesel

Data sheet
437.5 kVA Standby



Our energy working for you.™

Spec sheet:	SS9-CPGK
Noise data sheet (Open/enclosed):	ND50-OS550 / ND50-CS550
Airflow data sheet:	AF50-550
Derate data sheet (Open/enclosed):	DD50-OS550 / DD50-CS550
Transient data sheet:	TD50-550

Fuel consumption	Standby				Prime			
	Kw (kVA)				Kw (kVA)			
Ratings	350 (437.5)				320 (400)			
Load	1/4	1/2	3/4	Full	1/4	1/2	3/4	Full
US gph	6.6	11.1	15.8	21.1	5.9	10.3	14.5	19.1
L/hr	30	50	72	96	27	47	66	87

Engine	Standby rating	Prime rating
Engine manufacturer	Cummins	
Engine model	NTA855 G3	
Configuration	4 Cycle; In-line; 6 Cylinder Diesel	
Aspiration	Turbo Charged	
Gross engine power output, kW/m	399	358
BMEP at set rated load, kPa	1896	1703
Bore, mm	140	
Stroke, mm	152	
Rated speed, rpm	1800	
Piston speed, m/s	9.1	
Compression ratio	14:1	
Lube oil capacity, L	36	
Overspeed limit, rpm	2100 ±50	
Regenerative power, kW	22	
Governor type	Electronic	
Starting voltage	24 Volts DC	

Fuel flow	
Maximum fuel flow, L/hr	405
Maximum fuel inlet restriction, mm Hg	203
Maximum fuel inlet temperature (°C)	70

Air	
Combustion air, m ³ /min	32.6
Maximum air cleaner restriction, kPa	6.2



Exhaust

	Standby rating	Prime rating
Exhaust gas flow at set rated load, m ³ /min	90.4	78.9
Exhaust gas temperature, °C	527	521
Maximum exhaust back pressure, kPa	10.2	

Standard set-mounted radiator cooling

Ambient design, °C	50	
Fan load, KW _m	19	
Coolant capacity (with radiator), L	45	
Cooling system air flow, m ³ /min @ 12.7mmH ₂ O	7.2	
Total heat rejection, BTU/min	13375	12000
Maximum cooling air flow static restriction mmH ₂ O	19.1	



TAL 046

Low Voltage Alternator - 4 pole

180 to 365 kVA - 50 Hz / 225 to 438 kVA - 60 Hz
Electrical and mechanical data

LEROY-SOMER™

Nidec
All for dreams

Adapted to needs

The TAL alternator range is designed to meet the needs of general applications such as prime power and stand-by.

Compliant with international standards

The TAL range complies with international standards and regulations: IEC 60034 and derivative.

The range is designed, manufactured and marketed in an ISO 9001 and 14001 environment.

Electrical design

- Class H insulation
- Shunt excitation
- Low voltage winding:
 - Three-phase 50 Hz: 380V - 400V - 415V - 440V / 220V - 230V - 240V
 - 60 Hz: 380V - 416V - 440V - 480V / 220V - 208V - 240V
- 6-terminal plates in 6-wire version or suitable for 12-wire option
- Optimized performance

Robust design

- Compact and rugged assembly to withstand engine vibrations
- Steel frame
- Cast iron flanges and shields
- Single bearing design to be suitable with most diesel engines
- Sealed for life bearing
- Direction of rotation: clockwise and counterclockwise without derating



Excitation and regulation system suited to the application

	Excitation system				Regulation options		
	AVR	Shunt	AREP	PMG	ULc/us	Remote voltage potentiometer	C.T. for paralleling
Three-phase 6-wire	R150	Standard				√	
	R180		Standard	Standard		√	√
	R450		Option	Option	√	√	√
Three-phase 12-wire*	R250	Standard			√	√	
	R180		Standard	Standard		√	√
	R450		Option	Option	√	√	√

√ : Possible option *with larger terminal box

Compact terminal box

- Easy access to AVR and terminals
- Standard terminal box with possibility of mounting measurement CTs
- Possibility of current transformer for parallel operation

Environment and protection

- IP Code IP 23
- Standard winding protection for non-harsh environments with relative humidity ≤ 95%

Available options

- Three-phase 12-wire with 9-terminal plates
- AREP or PMG excitation
- ULc/us
- Customized painting
- Space heaters
- Droop kit for alternator paralleling
- Stator sensors
- Winding 8 optimized for three-phase 380V - 416 V / 60 Hz
- Winding protection for harsh environments and relative humidity greater than 95% (system 2 - 4): for TAL 046 H apply a derating coefficient of 0.97

TAL 046 - 180 to 365 kVA - 50 Hz / 225 to 438 kVA - 60 Hz

General characteristics

Insulation class	H	Excitation system 6-wire	SHUNT	AREP / PMG
Winding pitch	2/3 (wind.6S - 6-wire / wind.6 - 12-wire)	AVR type	R150	R180
Number of wires	6-wire (12-wire option)	Excitation system 12-wire (option)	SHUNT	AREP / PMG
Protection	IP 23	AVR type	R250	R180
Altitude	≤ 1000 m	Voltage regulation (*)	± 1 %	
Overspeed	2250 R.P.M.	Total Harmonic Distortion THD (**) in no-load	< 2.5 %	
Air flow (m³/s)	0.48	Total Harmonic Distortion THD (**) in linear load	< 5 %	
Air flow (m³/s)	0.58	Waveform: NEMA = TIF (**)	< 50	
AREP Short-circuit current = 2.7 In: 5 second		Waveform: I.E.C. = THF (**)	< 2%	

(*) Steady state (**) Total harmonic distortion between phases, no-load or on-load (non-distorting)

Ratings 50 Hz - 1500 R.P.M.

kVA / kW - P.F. = 0.8

Duty / T° C	Continuous / 40 °C				Continuous / 40 °C				Stand-by / 40 °C				Stand-by / 27 °C							
Class / T° K	H / 125° K				F / 105° K				H / 150° K				H / 163° K							
Phase	3 ph.		1 ph.		3 ph.		1 ph.		3 ph.		1 ph.		3 ph.		1 ph.					
Y	380V	400V	415V	440V	380V	400V	415V	440V	380V	400V	415V	440V	380V	400V	415V	440V				
Δ	220V	230V	240V	230V	220V	230V	240V	230V	220V	230V	240V	230V	220V	230V	240V	230V				
YY (*)	200V		220V		200V		220V		200V		220V		200V		220V					
ΔΔ (*)				230V				230V				230V				230V				
TAL 046 A kVA	180	180	180	171	108	164	164	164	156	98	191	191	191	181	114	200	200	200	188	119
kW	144	144	144	137	86	131	131	131	125	78	153	153	153	145	91	160	160	160	150	95
TAL 046 B kVA	200	200	200	190	120	182	182	182	173	109	212	212	212	201	127	220	220	220	209	132
kW	160	160	160	152	96	146	146	146	138	87	170	170	170	161	102	176	176	176	167	106
TAL 046 C kVA	230	230	230	219	138	209	209	209	199	126	244	244	244	232	146	253	253	253	241	152
kW	184	184	184	175	110	167	167	167	159	101	195	195	195	186	117	202	202	202	193	122
TAL 046 D kVA	240	250	250	238	150	218	228	228	217	137	254	265	265	252	159	264	275	275	262	165
kW	192	200	200	190	120	175	182	182	174	110	204	212	212	202	127	211	220	220	210	132
TAL 046 E kVA	275	275	275	261	165	250	250	250	238	150	292	292	292	277	175	303	303	303	287	182
kW	220	220	220	209	132	200	200	200	190	120	234	234	234	222	140	242	242	242	230	146
TAL 046 F kVA	290	300	300	285	180	264	273	273	259	164	307	318	318	302	191	319	330	330	314	198
kW	232	240	240	228	144	211	218	218	207	131	246	254	254	242	153	255	264	264	251	158
TAL 046 G kVA	325	325	325	309	195	296	296	296	281	177	345	345	345	328	207	360	360	360	340	215
kW	260	260	260	247	156	237	237	237	225	142	276	276	276	262	166	288	288	288	272	172
TAL 046 H kVA	350	365	365	347	210	318	332	332	316	191	371	387	387	368	223	385	400	400	382	231
kW	280	292	292	278	168	255	266	266	253	153	297	310	310	294	178	308	320	320	306	185

(*) 12-wire option

Ratings 60 Hz - 1800 R.P.M.

kVA / kW - P.F. = 0.8

Duty / T° C	Continuous / 40 °C				Continuous / 40 °C				Stand-by / 40 °C				Stand-by / 27 °C							
Class / T° K	H / 125° K				F / 105° K				H / 150° K				H / 163° K							
Phase	3 ph.		1 ph.		3 ph.		1 ph.		3 ph.		1 ph.		3 ph.		1 ph.					
Y	380V	416V	440V	480V	380V	416V	440V	480V	380V	416V	440V	480V	380V	416V	440V	480V				
Δ	220V	240V		240V	220V	240V		240V	220V	240V		240V	220V	240V		240V				
YY (*)	208V		220V		208V		220V		208V		220V		208V		220V					
ΔΔ (*)				240V				240V				240V				240V				
TAL 046 A kVA	180	195	210	225	120	164	177	191	205	109	191	207	223	239	127	200	215	230	250	132
kW	144	156	168	180	96	131	142	153	164	87	153	166	178	191	102	160	172	184	200	106
TAL 046 B kVA	200	215	230	250	132	182	196	209	228	120	212	228	244	265	140	220	237	253	275	145
kW	160	172	184	200	106	146	157	167	182	96	170	182	195	212	112	176	190	202	220	116
TAL 046 C kVA	226	250	262	288	152	206	228	238	262	138	240	265	278	305	161	250	275	288	316	167
kW	181	200	210	230	122	165	182	190	210	110	192	212	222	244	129	200	220	230	253	134
TAL 046 D kVA	245	265	280	313	165	223	241	255	285	150	260	281	297	332	175	270	292	308	344	182
kW	196	212	224	250	132	178	193	204	228	120	208	225	238	266	140	216	234	246	275	146
TAL 046 E kVA	275	300	315	344	182	250	273	287	313	166	292	318	334	365	193	303	330	347	378	200
kW	220	240	252	275	146	200	218	230	250	133	234	254	267	292	154	242	264	278	302	160
TAL 046 F kVA	290	315	340	360	200	264	287	309	328	182	307	334	360	382	212	320	347	374	400	220
kW	232	252	272	288	160	211	230	247	262	146	246	267	288	306	170	256	278	299	320	176
TAL 046 G kVA	315	345	365	406	215	287	314	332	369	196	334	366	387	430	228	347	380	402	447	237
kW	252	276	292	325	172	230	251	266	295	157	267	293	310	344	182	278	304	322	358	190
TAL 046 H kVA	345	375	400	438	231	314	341	364	399	210	366	398	424	464	245	380	413	440	480	254
kW	276	300	320	350	185	251	273	291	319	168	293	318	339	371	196	304	330	352	384	203

(*) 12-wire option

Efficiencies 400 V - 50 Hz (— P.F.: 0.8) (..... P.F.: 1)

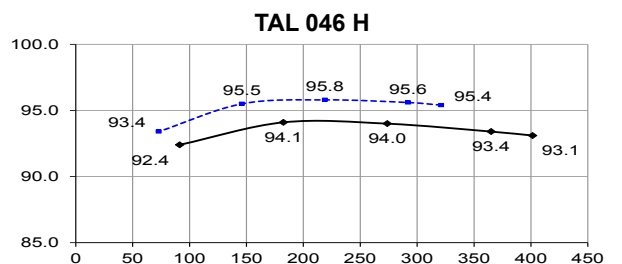
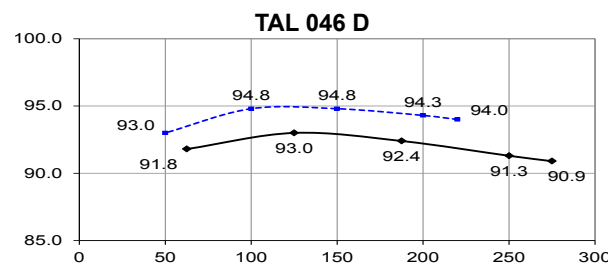
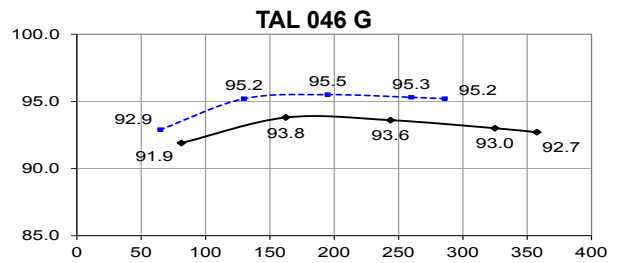
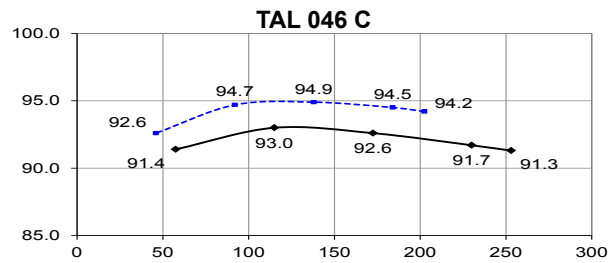
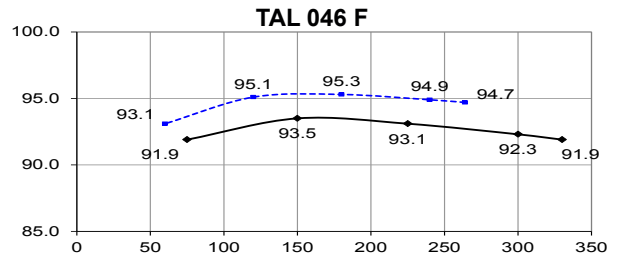
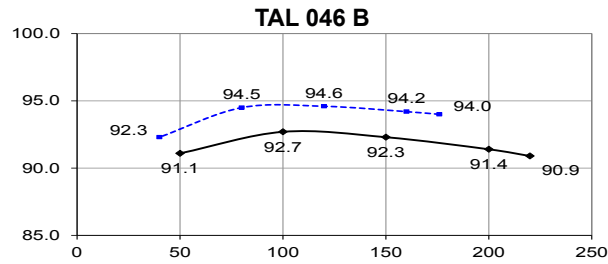
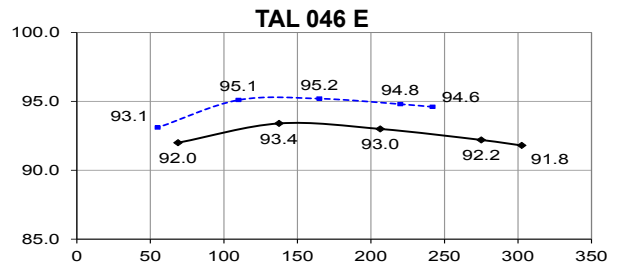
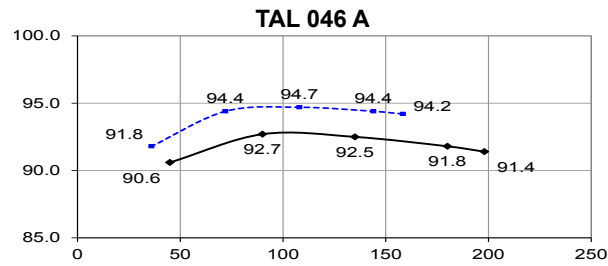

Reactances (%). Time constants (ms) - Class H / 400 V

	A	B	C	D	E	F	G	H
Kcc Short-circuit ratio	0.39	0.35	0.37	0.34	0.37	0.4	0.45	0.43
Xd Direct-axis synchro. reactance unsaturated	313	348	340	370	347	335	297	303
Xq Quadrature-axis synchro. reactance unsaturated	159	177	173	188	177	171	151	154
T'do No-load transient time constant	1956	1956	1983	1983	2018	2033	2072	2093
X'd Direct-axis transient reactance saturated	16	17.7	17.1	18.6	17.1	16.5	14.3	14.5
T'd Short-circuit transient time constant	100	100	100	100	100	100	100	100
X''d Direct-axis subtransient reactance saturated	12.8	14.2	13.7	14.9	13.7	13.2	11.4	11.6
T''d Subtransient time constant	10	10	10	10	10	10	10	10
X''q Quadrature-axis subtransient reactance saturated	16.4	18.2	17.4	18.9	17.2	16.4	14.1	14.2
Xo Zero sequence reactance	0.66	0.74	0.71	0.77	0.71	0.68	0.59	0.6
X2 Negative sequence reactance saturated	14.6	16.2	15.6	16.9	15.5	14.8	12.8	12.9
Ta Armature time constant	15	15	15	15	15	15	15	15

Other class H / 400 V data

io (A) No-load excitation current SHUNT/AREP	0.95	0.95	1.01	1.01	1.1	1.1	1.06	1.06
ic (A) On-load excitation current SHUNT/AREP	3.4	3.72	3.84	4.14	3.99	3.64	3.63	3.63
uc (V) On-load excitation voltage SHUNT/AREP	48	52.4	37.4	40.2	55.6	46.2	42.1	41.9
ms Response time ($\Delta U = 20\%$ transient)	500	500	500	500	500	500	500	500
kVA Start ($\Delta U = 20\%$ cont. or $\Delta U = 30\%$ trans.) SHUNT*	311	311	372	371	444	445	556	618
kVA Start ($\Delta U = 20\%$ cont. or $\Delta U = 30\%$ trans.) AREP*	374	376	446	447	533	534	667	741
% Transient ΔU (on-load 4/4) SHUNT - P.F.: 0.8 _{LAG}	17.1	18.4	18	19.1	18	19.1	17.4	17.4
% Transient ΔU (on-load 4/4) AREP - P.F.: 0.8 _{LAG}	15.1	16.2	15.8	16.8	16.2	17.2	17.3	15.4
W No-load losses	2977	2977	3297	3297	3625	4013	4541	4750
W Heat dissipation	12841	15040	16562	18869	18504	19800	19303	20484

* P.F. = 0.6

Transient voltage variation 400 V - 50 Hz

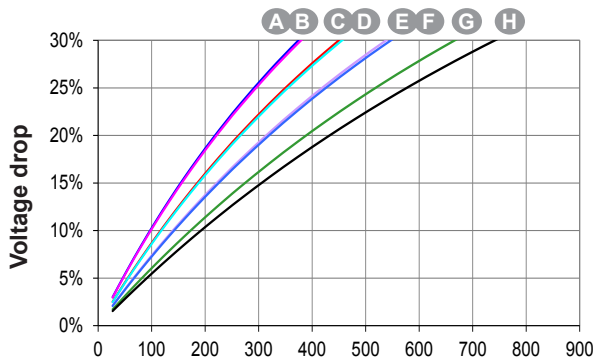

Phase loading (SHUNT) - kVA at P.F. = 0.8

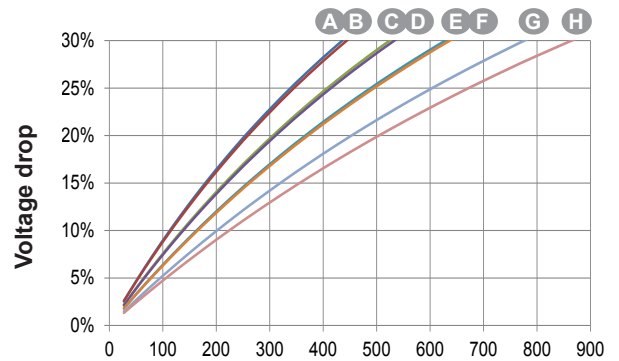

Phase loading (AREP) - kVA at P.F. = 0.8

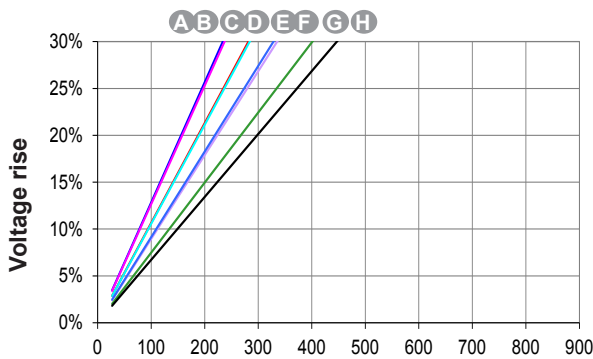

Load shedding (SHUNT) - kVA at P.F. = 0.8

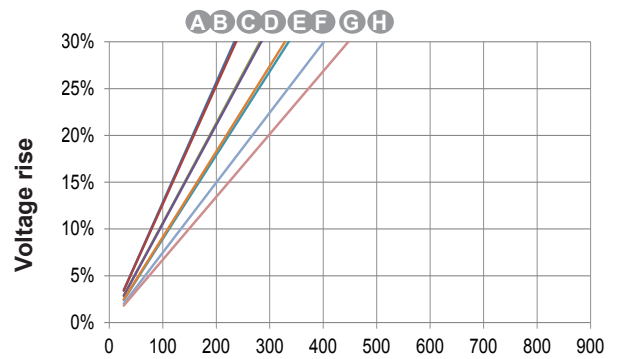

Load shedding (AREP) - kVA at P.F. = 0.8

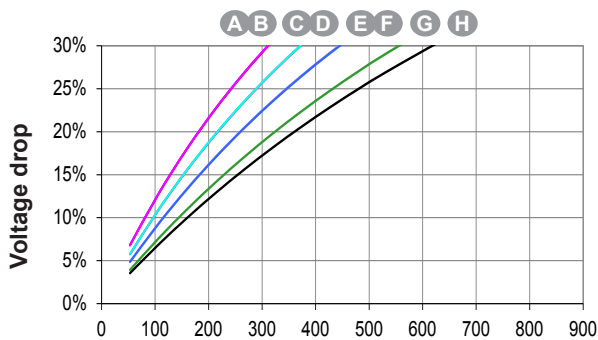

Motor starting (SHUNT)
Locked rotor kVA at P.F. = 0.6

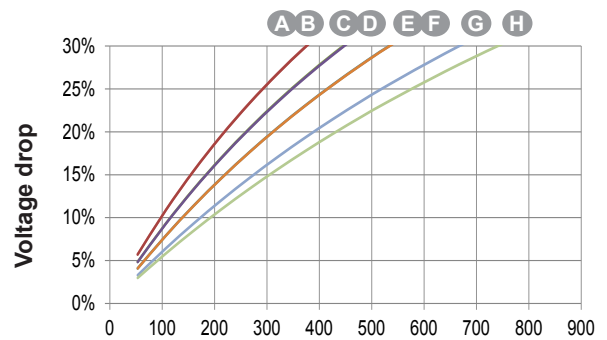

Motor starting (AREP)
Locked rotor kVA at P.F. = 0.6

- 1) For a starting P.F. other than 0.6, the starting kVA must be multiplied by $K = \text{Sine P.F.} / 0.8$
- 2) For voltages other than 400V (Y), 230V (Δ) at 50 Hz, then kVA must be multiplied by $(400/U)^2$ or $(230/U)^2$.

Efficiencies 480 V - 60 Hz (— P.F.: 0.8) (----- P.F.: 1)

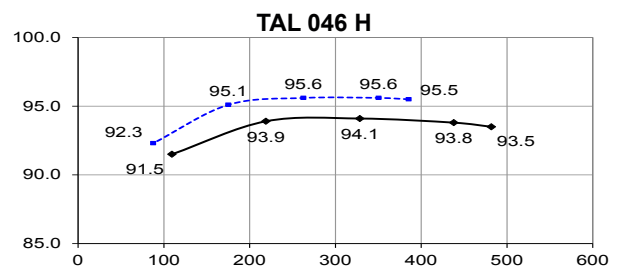
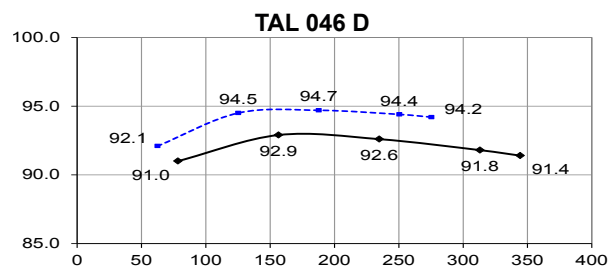
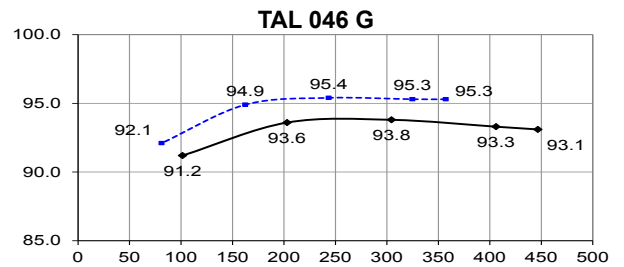
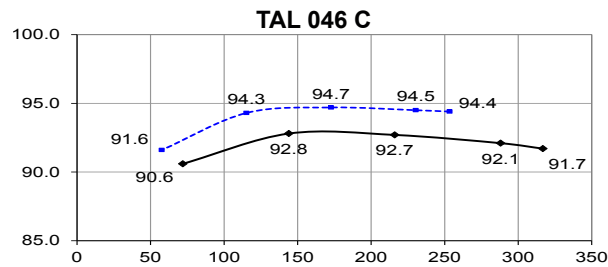
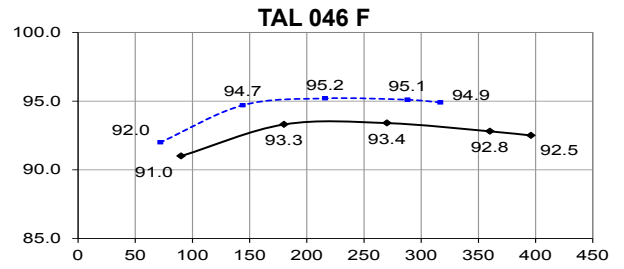
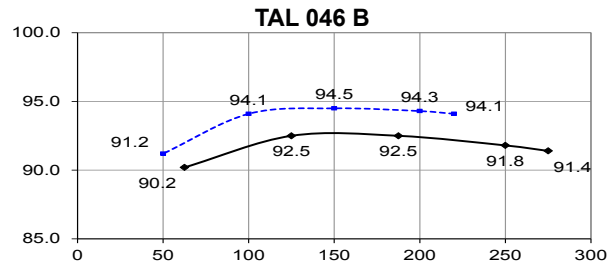
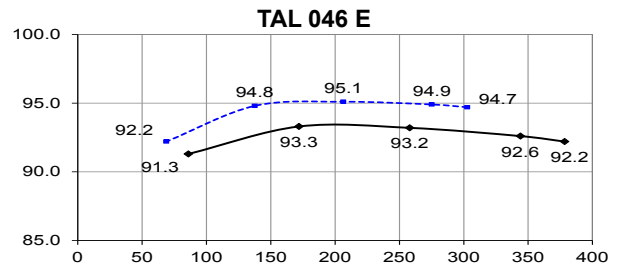
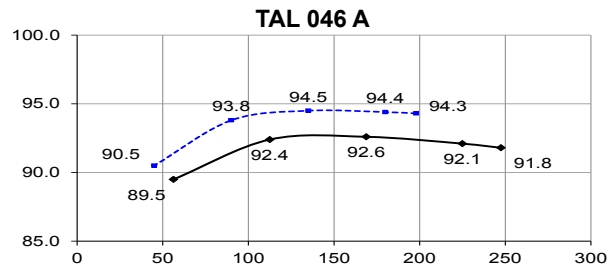

Reactances (%). Time constants (ms) - Class H / 480 V

	A	B	C	D	E	F	G	H
Kcc Short-circuit ratio	0.37	0.34	0.36	0.33	0.35	0.4	0.43	0.43
Xd Direct-axis synchro. reactance unsaturated	326	362	355	386	361	335	309	303
Xq Quadrature-axis synchro. reactance unsaturated	166	185	181	197	184	171	157	154
T'do No-load transient time constant	1956	1956	1983	1983	2018	2033	2072	2093
X'd Direct-axis transient reactance saturated	16.6	18.5	17.9	19.4	17.9	16.5	14.9	14.5
T'd Short-circuit transient time constant	100	100	100	100	100	100	100	100
X''d Direct-axis subtransient reactance saturated	13.3	14.8	14.3	15.5	14.3	13.2	11.9	11.6
T''d Subtransient time constant	10	10	10	10	10	10	10	10
X''q Quadrature-axis subtransient reactance saturated	17	18.9	18.1	19.7	18	16.4	14.7	14.2
Xo Zero sequence reactance	0.69	0.77	0.74	0.81	0.74	0.68	0.62	0.6
X2 Negative sequence reactance saturated	15.2	16.9	16.2	17.6	16.2	14.8	13.3	12.9
Ta Armature time constant	15	15	15	15	15	15	15	15

Other class H / 480 V data

io (A) No-load excitation current SHUNT/AREP	0.94	0.94	1.01	1.01	1.03	1.1	1.1	1.06
ic (A) On-load excitation current SHUNT/AREP	3.46	3.79	3.91	4.21	4.03	3.91	3.69	3.56
uc (V) On-load excitation voltage SHUNT/AREP	49	53.6	38.3	41.1	56.7	45.5	42.9	41.3
ms Response time (ΔU = 20% transient)	500	500	500	500	500	500	500	500
kVA Start (ΔU = 20% cont. or ΔU = 30% trans.) SHUNT*	376	376	446	448	532	534	665	742
kVA Start (ΔU = 20% cont. or ΔU = 30% trans.) AREP*	450	450	537	536	639	640	798	889
% Transient ΔU (on-load 4/4) SHUNT - P.F.: 0.8 _{LAG}	17.6	19	18.5	19.6	18.5	19.1	17.8	17.4
% Transient ΔU (on-load 4/4) AREP - P.F.: 0.8 _{LAG}	15.5	16.7	16.3	17.3	16.7	17.2	16	15.7
W No-load losses	4522	4522	4958	4958	5412	5935	6673	6978
W Heat dissipation	15376	17830	19674	22244	21910	22085	23012	23141

* P.F. = 0.6

Transient voltage variation 480 V - 60 Hz

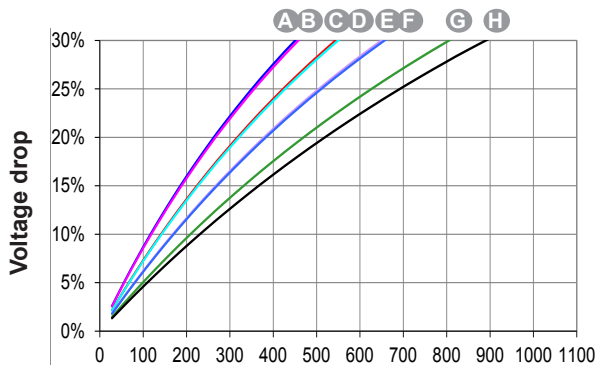

Phase loading (SHUNT) - kVA at P.F. = 0.8

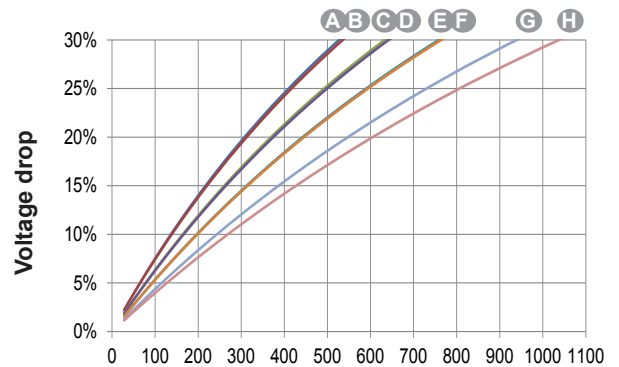

Phase loading (AREP) - kVA at P.F. = 0.8

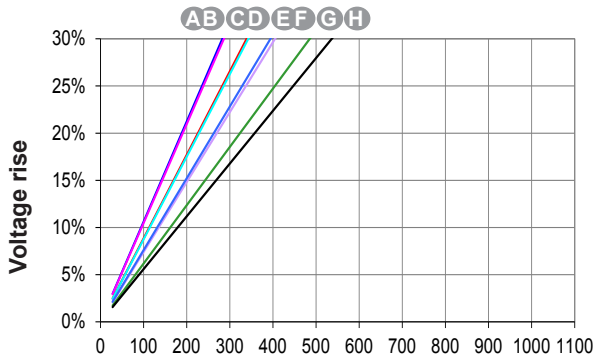

Load shedding (SHUNT) - kVA at P.F. = 0.8

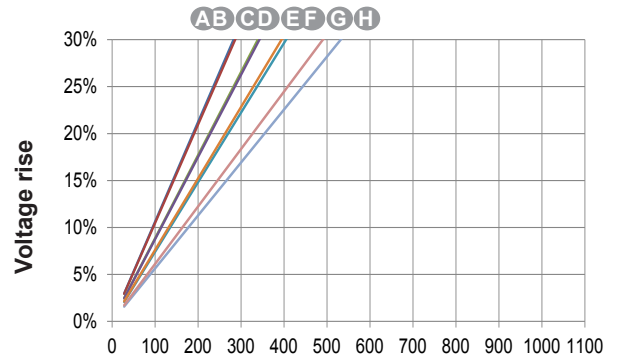

Load shedding (AREP) - kVA at P.F. = 0.8

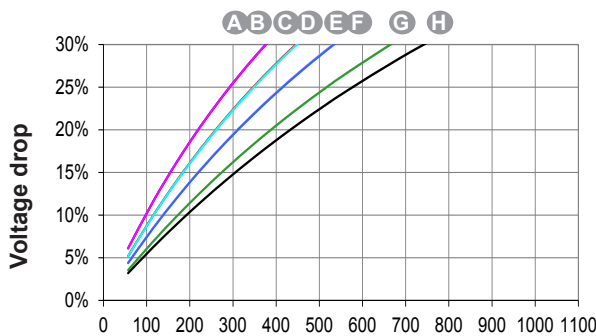

Motor starting (SHUNT)
Locked rotor kVA at P.F. = 0.6

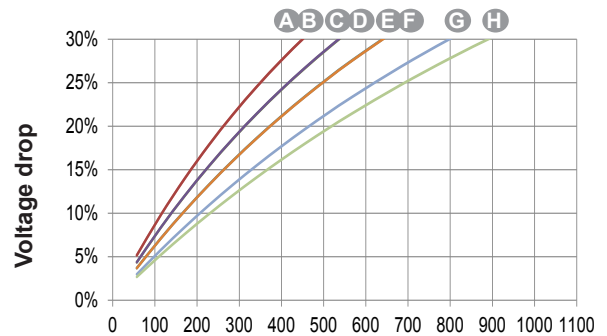

Motor starting (AREP)
Locked rotor kVA at P.F. = 0.6

- 1) For a starting P.F. other than 0.6, the starting kVA must be multiplied by $K = \text{Sine P.F.} / 0.8$
- 2) For voltages other than 480V (Y), 277V (Δ), 240V (YY) at 60 Hz, then kVA must be multiplied by $(480/U)^2$ or $(277/U)^2$ or $(240/U)^2$.

3-phase short-circuit curves at no load and rated speed (star connection Y)

TAL 046 A

Symmetrical —
Asymmetrical - - -

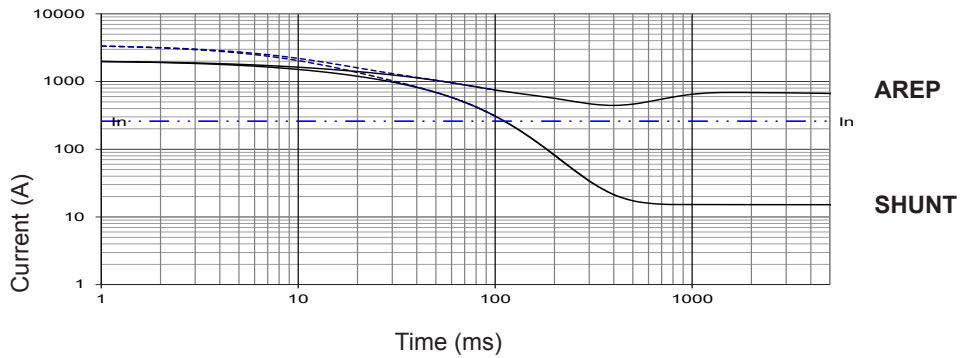

TAL 046 B

Symmetrical —
Asymmetrical - - -

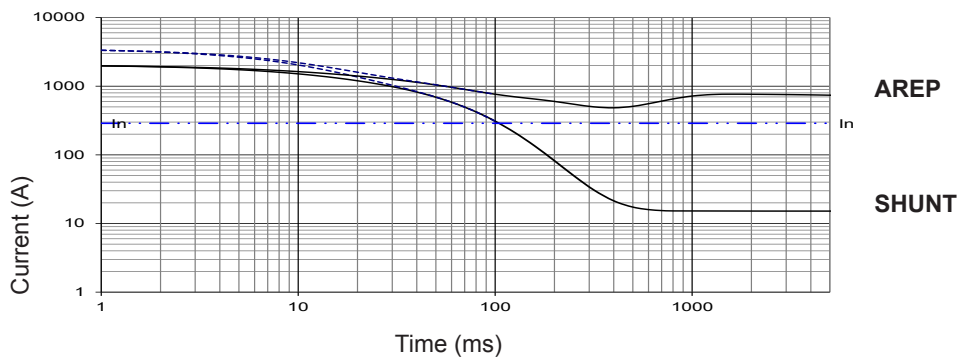

TAL 046 C

Symmetrical —
Asymmetrical - - -

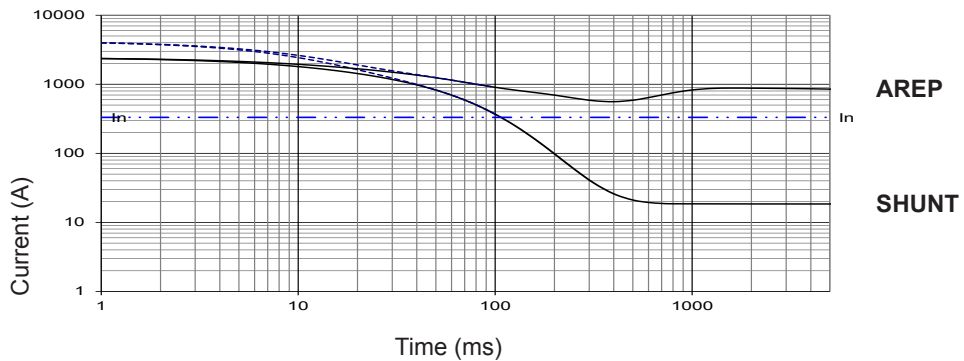

TAL 046 D

Symmetrical —
Asymmetrical - - -

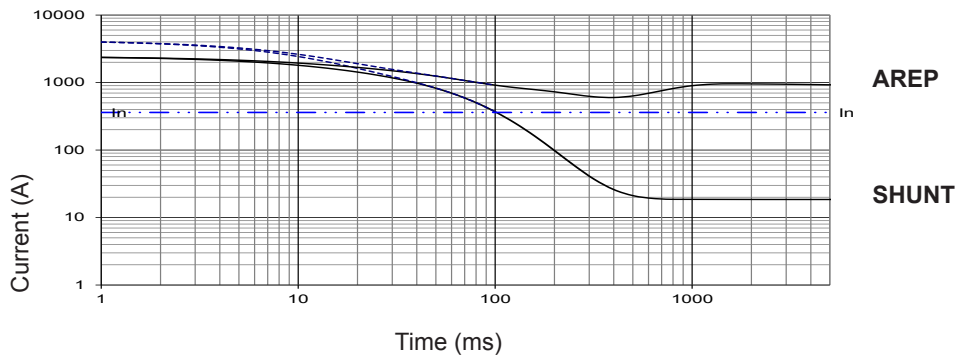

Influence due to connection

For (Δ) connection, use the following multiplication factor:
- Current value x 1.732.

3-phase short-circuit curves at no load and rated speed (star connection Y)

TAL 046 E

Symmetrical —
Asymmetrical - - -

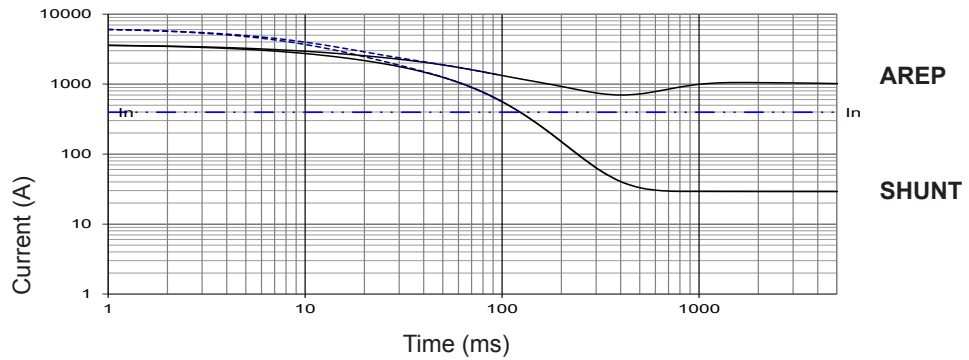

TAL 046 F

Symmetrical —
Asymmetrical - - -

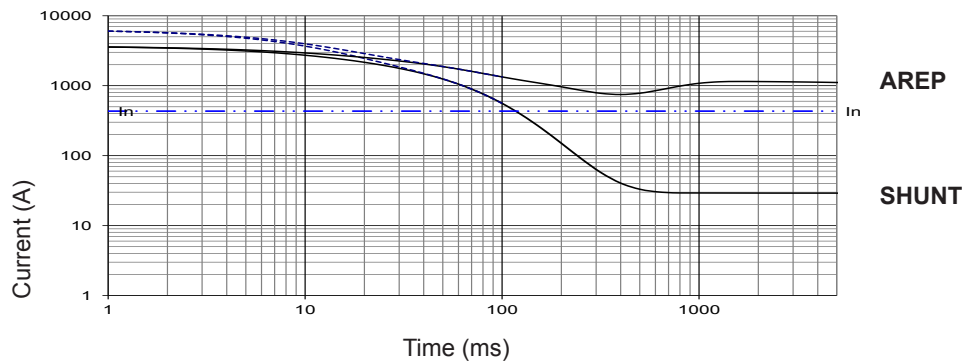

TAL 046 G

Symmetrical —
Asymmetrical - - -

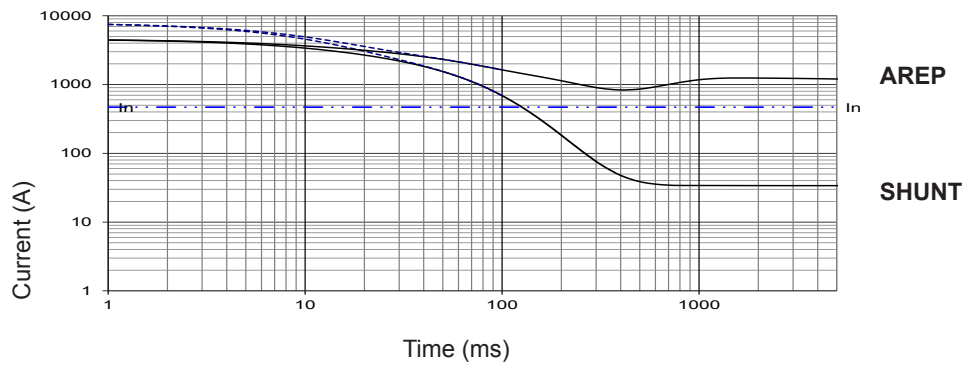

TAL 046 H

Symmetrical —
Asymmetrical - - -

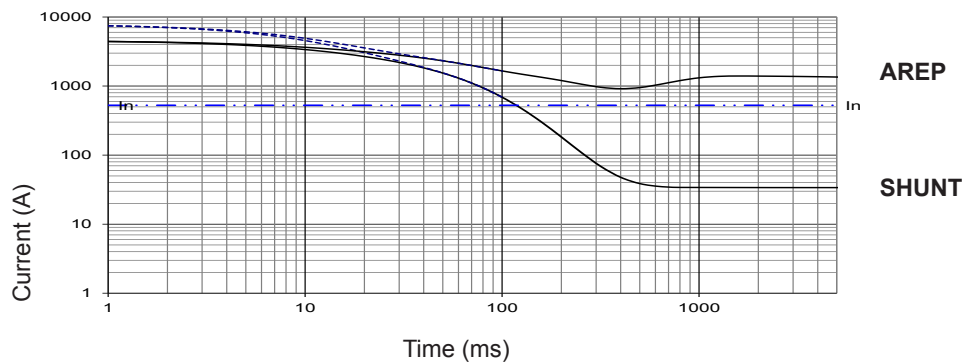

Influence due to short-circuit

Curves are based on a three-phase short-circuit.
For other types of short-circuit,
use the following multiplication factors.

	3 - phase	2 - phase L / L	1 - phase L / N
Instantaneous (max.)	1	0.87	1.3
Continuous	1	1.5	2.2
Maximum duration		1.5	

Single bearing general arrangement

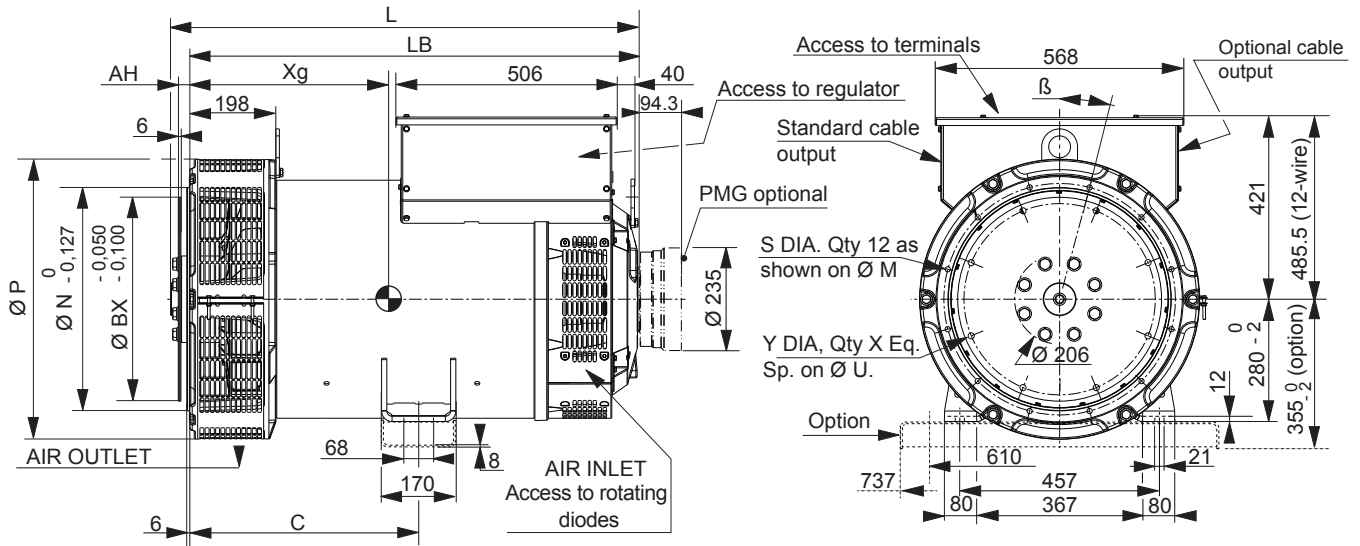

Dimensions (mm) and weight					
Type	L without PMG	LB	Xg	C	Weight (kg)
TAL 046 A	944**/935	892	408	429	569
TAL 046 B	944**/935	892	414	429	599
TAL 046 C	944**/935	892	423	429	674
TAL 046 D	944**/935	892	423	429	682
TAL 046 E	989**/980	937	445	429	754
TAL 046 F	989**/980	937	445	429	754
TAL 046 G*	1084**/1075	1032	493	525	888
TAL 046 H*	1084**/1075	1032	493	525	888

Coupling				
Flex plate	11 1/2	14	18	
Flange S.A.E 3	X			
Flange S.A.E 2	X			
Flange S.A.E 1	X	X		
Flange S.A.E 1/2		X		
Flange S.A.E 0		X	X	

* Shaft height = 355 mm optional
 ** Dimensions with SAE 11 1/2

Flange (mm)					
S.A.E.	P	N	M	S	β °
3	641	409.575	428.625	11	15°
2	641	447.675	466.725	11	15°
1	641	511.175	530.225	12	15°
1/2	713	584.2	619.125	14	15°
0	713	647.7	679.45	14	11° 15'

Flex plate (mm)					
S.A.E.	BX	U	X	Y	AH
11 1/2	352.42	333.38	8	11	39.6
14	466.72	438.15	8	14	25.4
18***	571.5	542.92	6	17	15.7

*** Option

Torsional data

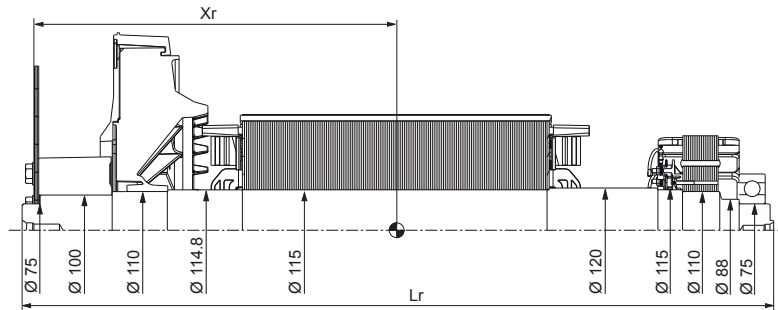

Centre of gravity: Xr (mm), Rotor length: Lr (mm), Weight: M (kg), Moment of inertia: J (kgm²): (4J = MD²)								
Type	Flex plate S.A.E. 11 1/2				Flex plate S.A.E. 14			
	Xr	Lr	M	J	Xr	Lr	M	J
TAL 046 A	413	923	243	2.46	401	923	244	2.62
TAL 046 B	413	923	243	2.46	401	923	244	2.62
TAL 046 C	420	923	255	2.64	408	923	256	2.8
TAL 046 D	420	923	255	2.64	408	923	256	2.8
TAL 046 E	460	968	304	3.28	448	968	305	3.44
TAL 046 F	460	968	304	3.28	448	968	305	3.44
TAL 046 G	508	1063	358	3.97	497	1063	359	4.13
TAL 046 H	508	1063	358	3.97	497	1063	359	4.13

NOTE : Dimensions are for information only and may be subject to modifications. The torsional analysis of the transmission is imperative. All values are available upon request.

LEROY-SOMER[™]

www.leroy-somer.com/epg

[Linkedin.com/company/Leroy-Somer](https://www.linkedin.com/company/Leroy-Somer)
[Twitter.com/Leroy_Somer_en](https://twitter.com/Leroy_Somer_en)
[Facebook.com/LeroySomer.Nidec.en](https://www.facebook.com/LeroySomer.Nidec.en)
[YouTube.com/LeroySomerOfficiel](https://www.youtube.com/LeroySomerOfficiel)



Nidec
All for dreams

© Nidec 2017. The information contained in this brochure is for guidance only and does not form part of any contract. The accuracy cannot be guaranteed as Nidec have an ongoing process of development and reserve the right to change the specification of their products without notice.

Moteurs Leroy-Somer SAS. Siège : Bd Marcellin Leroy, CS 10015, 16915 Angoulême Cedex 9, France.
Capital social : 65 800 512 €, RCS Angoulême 338 567 258.

DSE7310/20

AUTO START & AUTO MAINS FAILURE CONTROL MODULES

FEATURES



The DSE7310 is an Auto Start Control Module and the DSE7320 is an Auto Mains (Utility) Failure Control Module suitable for a wide variety of single, diesel or gas, gen-set applications.

Monitoring an extensive number of engine parameters, the modules will display warnings, shutdown and engine status information on the back-lit LCD screen, illuminated LEDs, remote PC and via SMS text alerts (with external modem).

The DSE7320 will also monitor the mains (utility) supply. The modules include USB, RS232 and RS485 ports as well as dedicated DSENet® terminals for system expansion.

Both modules are compatible with electronic (CAN) and non-electronic (magnetic pick-up/alternator sensing) engines and offer an extensive number of flexible inputs, outputs and extensive engine protections so the system can be easily adapted to meet the most demanding industry requirements.

The extensive list of features includes enhanced event and performance monitoring, remote communications, PLC functionality and dual mutual standby (DSE7310 only) to reduce engine wear.

The modules can be easily configured using the DSE Configuration Suite PC software. Selected front panel editing is also available.

ENVIRONMENTAL TESTING STANDARDS

ELECTRO-MAGNETIC COMPATIBILITY

BS EN 61000-6-2
EMC Generic Immunity Standard for the Industrial Environment
BS EN 61000-6-4
EMC Generic Emission Standard for the Industrial Environment

ELECTRICAL SAFETY

BS EN 60950
Safety of Information Technology Equipment, including Electrical Business Equipment

TEMPERATURE

BS EN 60068-2-1
Ab/Ae Cold Test -30 °C
BS EN 60068-2-2
Bb/Be Dry Heat +70 °C

VIBRATION

BS EN 60068-2-6
Ten sweeps in each of three major axes
5 Hz to 8 Hz @ +/-7.5 mm,
8 Hz to 500 Hz @ 2 gn

HUMIDITY

BS EN 60068-2-30
Db Damp Heat Cyclic 20/55 °C @ 95% RH 48 Hours
BS EN 60068-2-78
Cab Damp Heat Static 40 °C @ 93% RH 48 Hours

SHOCK

BS EN 60068-2-27
Three shocks in each of three major axes
15 gn in 11 mS

DEGREES OF PROTECTION PROVIDED BY ENCLOSURES

BS EN 60529
IP65 - Front of module when installed into the control panel with the supplied sealing gasket.

COMPREHENSIVE FEATURE LIST TO SUIT A WIDE VARIETY OF GEN-SET APPLICATIONS

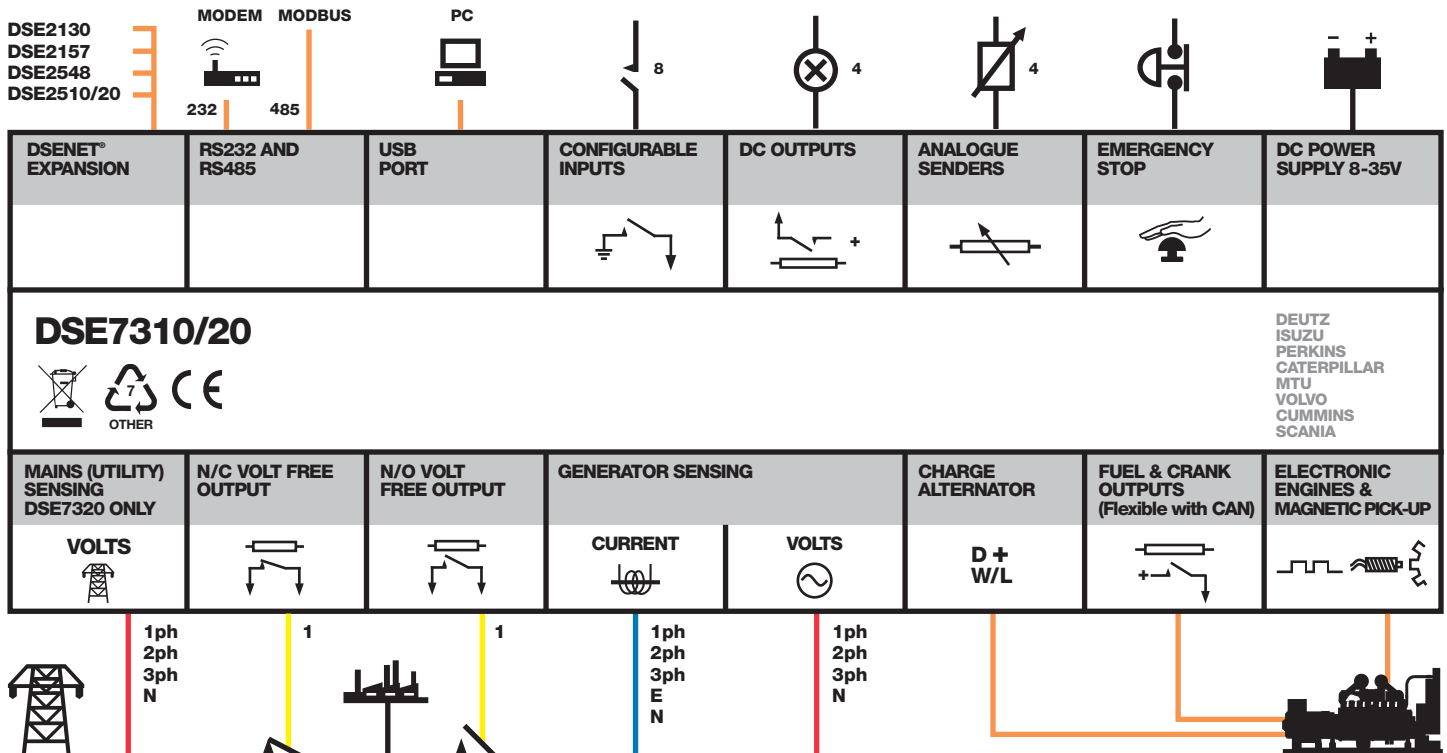

DSE7310/20

AUTO START & AUTO MAINS FAILURE CONTROL MODULES

FEATURES



DSE7310



KEY FEATURES

- 4-Line back-lit LCD text display
- Five key menu navigation
- Front panel editing with PIN protection
- Customisable status screens
- Power save mode
- Support for up to three remote display units
- 9 configurable inputs
- 8 configurable outputs
- Flexible sender inputs
- Configurable timers and alarms
- 3 configurable maintenance alarms
- Multiple date and time scheduler
- Configurable event log (250)
- Tier 4 CAN engine support
- Integral PLC editor
- Easy access diagnostic page
- CAN and Magnetic Pick-up/Alt. sensing
- Fuel usage monitor and low fuel alarms
- Charge alternator failure alarm
- Manual speed control (on compatible CAN engines)
- Manual fuel pump control
- Engine exerciser
- "Protections disabled" feature
- kW & kV Ar protection

DSE7320



- Reverse power (kW & kV Ar) protection
- LED and LCD alarm indication
- Power monitoring (kW h, kV Ar, kV A h, kV Ar h)
- Load switching (load shedding and dummy load outputs)
- Automatic load transfer (DSE7320)
- Unbalanced load protection
- Independent Earth Fault trip
- True dual mutual standby with load balancing timer (DSE7310 only)
- USB connectivity
- Backed up real time clock
- Fully configurable via DSE Configuration Suite PC software
- Configurable display languages
- Remote SCADA monitoring via DSE Configuration Suite PC software
- User selectable RS232 and RS485 communications
- Configurable Gencomm pages
- Advanced SMS messaging (additional external modem required)
- Start & stop capability via SMS messaging
- Additional display screens to help with modem diagnostics
- Idle control for starting & stopping.
- DSENet® expansion compatible

KEY BENEFITS

- 132 x 64 pixel ratio display for clarity
- Real-time clock provides accurate event logging
- Multiple date and time scheduler
- Set maintenance periods can be configured to maintain optimum engine performance
- Ethernet communications (via DSE860/865 modules), provides advanced remote monitoring at low cost
- Modules can be integrated into building management systems (BMS)
- Increased input and output expansion capability via DSENet®
- Licence-free PC software
- IP65 rating (with supplied gasket) offers increased resistance to water ingress
- PLC editor allows user configurable functions to meet specific application requirements

SPECIFICATION

DC SUPPLY

CONTINUOUS VOLTAGE RATING
8 V to 35 V Continuous

CRANKING DROPOUTS

Able to survive 0 V for 50 mS, providing supply was at least 10 V before dropout and supply recovers to 5 V. This is achieved without the need for internal batteries. LEDs and backlight will not be maintained during cranking.

MAXIMUM OPERATING CURRENT

340 mA at 12 V, 160 mA at 24 V

MAXIMUM STANDBY CURRENT

160 mA at 12 V, 80 mA at 24 V

CHARGE FAIL/EXCITATION RANGE

0 V to 35 V

MAINS (UTILITY) DSE7320 ONLY

VOLTAGE RANGE
15 V - 333 V AC (L-N)

FREQUENCY RANGE

3.5 Hz to 75 Hz

OUTPUTS

OUTPUT A (FUEL)

15 A DC at supply voltage

OUTPUT B (START)

15 A DC at supply voltage

OUTPUTS C & D

8 A 250 V (Volt free)

AUXILIARY OUTPUTS E,F,G,H

2 A DC at supply voltage

GENERATOR

VOLTAGE RANGE

15 V - 333 V AC (L-N)

FREQUENCY RANGE

3.5 Hz to 75 Hz

MAGNETIC PICK UP

VOLTAGE RANGE

+/- 0.5 V to 70 V

FREQUENCY RANGE

10,000 Hz (max)

DIMENSIONS

OVERALL

240 mm x 181 mm x 42 mm
9.4" x 7.1" x 1.6"

PANEL CUT-OUT

220 mm x 160 mm
8.7" x 6.3"

MAXIMUM PANEL THICKNESS

8 mm
0.3"

RELATED MATERIALS

TITLE

DSE7310 Installation Instructions
DSE7320 Installation Instructions
DSE7200/7300 Quick Start Guide
DSE7200/7300 Operator Manual
DSE7200/7300 Configuration Suite PC Manual

PART NO'S

053-028
053-029
057-101
057-074
057-077

DEEP SEA ELECTRONICS PLC UK

Highfield House, Hunmanby Industrial Estate, Hunmanby YO14 0PH
TELEPHONE +44 (0) 1723 890099 **FACSIMILE** +44 (0) 1723 893303
EMAIL sales@deepseapl.com **WEBSITE** www.deepseapl.com

DEEP SEA ELECTRONICS INC USA

3230 Williams Avenue, Rockford, IL 61101-2668 USA
TELEPHONE +1 (815) 316 8706 **FACSIMILE** +1 (815) 316 8708
EMAIL sales@deepseausa.com **WEBSITE** www.deepseausa.com